

Baterias Bosch para veículos pesados e fora de estrada. Confiança e performance em condições extremas.



Baterias Bosch S4, S5 e S6

Durabilidade incomparável e ótima relação custo-benefício para o seu negócio

Maior resistência

- ▶ Desenvolvidas para enfrentar períodos longos de trabalho pesado, grandes variações de temperatura e vibrações externas.
- ▶ Alto poder de arranque em qualquer condição climática.

Livres de manutenção

- ▶ Menor tempo parado para manutenção.

Polos forjados a frio

- ▶ Com baixa porosidade, eliminam a migração de ácido pelos polos (azinhavre).
- ▶ Mais proteção para os terminais externos da bateria, onde estão ligados os cabos para alimentação do circuito elétrico do veículo.

Separador de lã de vidro

- ▶ Melhor sustentação da massa.
- ▶ Maior resistência a vibrações e sobrecarga.

Fixação de placas

- ▶ Maior resistência a vibrações devido à utilização de uma cola que fixa as placas junto à caixa da bateria.

Esquema de montagem e quadros dimensionais

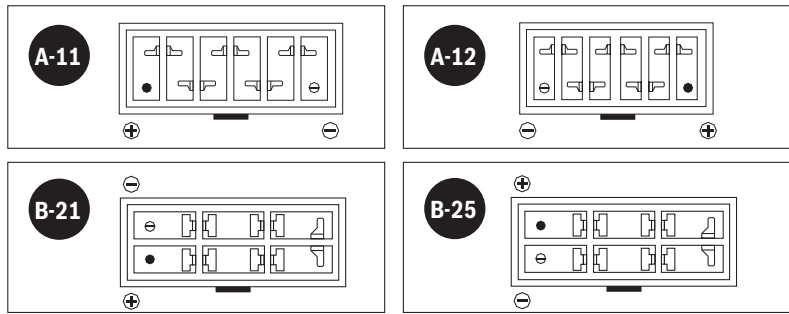

Tipos de polos terminais

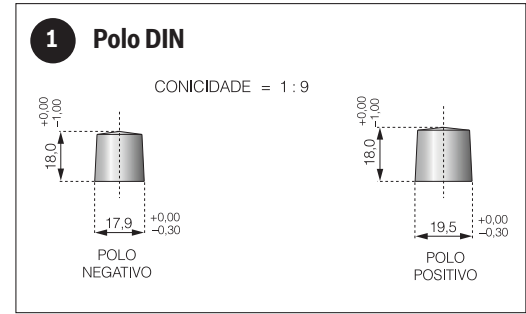

Características de fixação

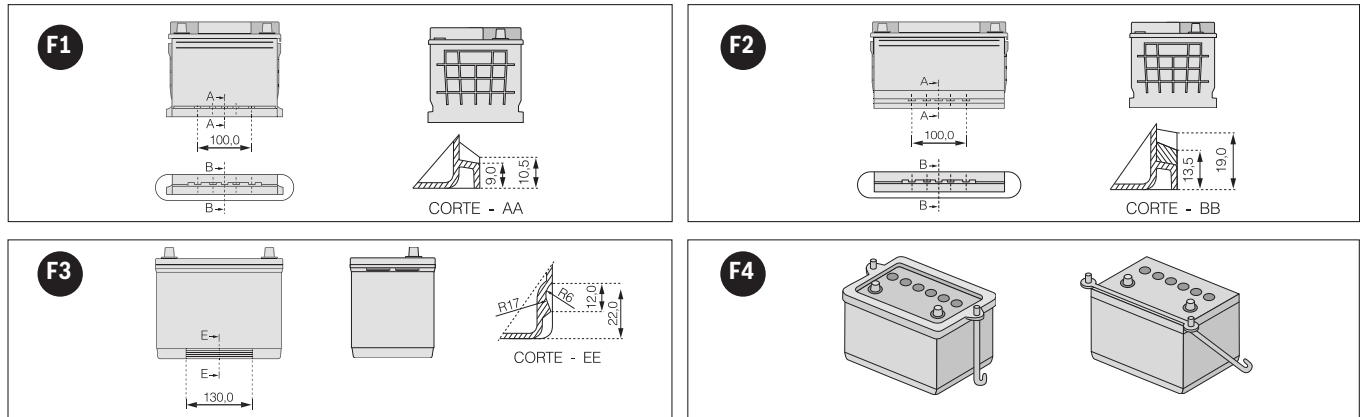

Programa de baterias – Linha pesada e fora de estrada

S4

Código simplificado Bosch	Número Bosch	Características elétricas			Dimensional (mm)			Esquema de montagem	Fix.	Tipo polo	Terminal positivo
		C20 (Ah)	RC (min.)	CCA -18 °C (A)	C	L	A				
S4X 115D	0 092 S48 155	115	230	820	510	213	235	B-21	F4	1	direita

S5

Código simplificado Bosch	Número Bosch	Características elétricas			Dimensional (mm)			Esquema de montagem	Fix.	Tipo polo	Terminal positivo
		C20 (Ah)	RC (min.)	CCA -18 °C (A)	C	L	A				
S5X 45D	0 092 S58 015	45	65	375	210	175	175	A12	F1	1	direita
S5X 55E	0 092 S58 095	55	90	425	240	175	175	A11	F1	1	esquerda
S5X 55D	0 092 S58 085	55	90	425	240	175	175	A12	F1	1	direita
S5X 60DH	0 092 S58 105	60	90	480	242	175	190	A12	F1	1	direita
S5X 65D	0 092 S58 125	65	105	600	281	175	175	A12	F2	1	direita
S5X 65E	0 092 S58 135	65	105	600	281	175	175	A11	F2	1	esquerda
S5X 75D	0 092 S58 145	75	105	530	273	170	226	A12	F3	1	direita
S5X 100E	0 092 S58 185	100	180	750	330	172	241	A-11	F4	1	esquerda
S5X 150D	0 092 S58 195	150	290	900	510	213	236	B-21	F4	1	direita
S5X 170D	0 092 S58 205	170	330	1000	510	213	236	B-21	F4	1	direita
S5X 180D	0 092 S58 365	180	360	1050	513	223	218	B-21	F4	1	direita
S5X 180E	0 092 S58 375	180	360	1050	513	223	218	B-25	F4	1	esquerda
S5X 200D	0 092 S58 235	200	360	1100	530	280	246	B-21	F4	1	direita

S6

Código simplificado Bosch	Número Bosch	Características elétricas			Dimensional (mm)			Esquema de montagem	Fix.	Tipo polo	Terminal positivo
		C20 (Ah)	RC (min.)	CCA -18 °C (A)	C	L	A				
S6X 60D	0 092 S68 035	60	90	480	240	175	175	A12	F1	1	direita
S6X 60E	0 092 S68 045	60	90	480	240	175	175	A11	F1	1	esquerda
S6X 70D	0 092 S68 055	70	115	660	281	175	175	A12	F2	1	direita
S6X 70E	0 092 S68 065	70	115	660	281	175	175	A11	F2	1	esquerda
S6X 95D ³	0 092 S68 195	95	170	800	350	172	190	A-12	F4	1	direita
S6X 150D	0 092 S68 075	150	290	900	510	213	236	B-21	F4	1	direita
S6X 170D	0 092 S68 085	170	330	1000	510	213	236	B-21	F4	1	direita

(3) S5X 95D substituída pela S6X 95D

				
Aplicação	Data de aplicação	Código simplificado Bosch		

AGRALE				
920 CE	Todos			S5X 100E
1600A / 1600D	10.85 → 12.95			S5X 100E
1800 DW	10.88 → 12.98	S6X 170D	S6X 150D	S5X 170D S5X 150D
4000 / 4200 / 4500D	09.94 → 12.04	S6X 170D	S6X 150D	S5X 170D S5X 150D
4100	12.74 →		S6X 150D	S5X 150D
4118	01.04 →		S6X 150D	S5X 150D
4230	05.79 →		S6X 150D	S5X 150D
4300	05.79 → 05.94		S6X 150D	S5X 150D
5000D	09.94 → 12.04		S6X 150D	S5X 150D
5070 / 5080	09.94 → 12.04		S6X 150D	S5X 150D
5075 / 5085	09.94 →		S6X 150D	S5X 150D
6000 / E-mec	04.00 →			S5X 100E
6000 Furgovan	01.02 → 12.05			S5X 100E
6000 Furgovan E-tronic	10.05 → 03.12			S5X 100E
7000 / 7500	05.93 → 12.05	S6X 170D	S6X 150D	S5X 170D S5X 150D
8500 TDX	07.97 → 09.05	S6X 170D	S6X 150D	S5X 170D S5X 150D
8500 E-mec/E-tronic	10.05 →		S6X 150D	S5X 150D
9200 E-tronic	10.05 →		S6X 170D	S5X 65D
13000	Todos		S6X 70E	S5X 65E
MA 7.5	09.96 → 12.05		S6X 150D	S5X 150D S4X 115D
MA 7.9	2011 →			S5X 100E
MA 8.5T	2011 →			S5X 100E
MA 8.5 E-tronic	2011 →			S5X 100E
MA 9.2	01.04 → 12.04			S5X 100E
MA 9.2 E-tronic	01.05 →		S6X 150D	S5X 150D
MA 10.0 / MA 15.0	08.07 →		S6X 150D	S5X 150D
TX 1100	01.82 → 09.85			S5X 100E
TX 1200	01.82 → 09.85		S6X 60E	S5X 55E
TX 1600	09.83 → 09.90			S5X 100E
TX 1600	01.91 →	S6X 170D	S6X 150D	S5X 170D S5X 150D
VOLARE	2002 →			S5X 100E
VOLARE W8/ W9	2008 → 2009		S6X 70E	S5X 65E
VOLARE W8/ W9	06.06 →			S5X 100E

CHEVROLET/GMC				
11000	03.85 → 10.96		S6X 170D	S5X 170D
12000	03.85 → 10.96		S6X 170D	S5X 170D
14000	03.85 → 10.96		S6X 170D	S5X 170D
5-90 / 6-100 / 6-150 / 7-110	08.96 → 12.01		S6X 70E	S5X 65E
12-170 / 12-190 / 14-190 / 15-190 / 16-220	08.95 → 12.01			S5X 100E
A40 / A60 / A70 / A80 / A90	01.85 → 12.95		S6X 60D	S5X 55D
AC 99 Canavieiro	01.85 →		S6X 70D	S5X 65D
C40 / C60 / C70 / C90	01.71 → 12.96		S6X 60D	S5X 55D
D40	01.85 → 12.96		S6X 70E	
D60	01.64 → 12.89		S6X 70D	S5X 65D
D6000	03.92 → 12.96		S6X 60E	S5X 55E
GMC 3500 HD	08.96 → 12.01		S6X 150D	S5X 150D S4X 115D
GMC 12170, 14190 E 16220 - Todos	1997 →			S5X 100E

CHRYSLER				
D 400	01.71 → 12.77		S6X 60D	S5X 60DH
E 11 / E13 / E21	01.82 → 12.85			S5X 100E



				
Aplicação	Data de aplicação	Código simplificado Bosch		

FORD

Cargo 712/814/815/816//915	10.85 →			S5X 100E	
Cargo 11t/12t/13t/14t/15t	Todos	S6X 150D		S5X 150D	
Cargo 14t/15t	Todos	S6X 150D		S5X 150D	
Cargo 16t/17t/18t/19t	Todos	S6X 150D		S5X 150D	
Cargo 22t/23t/24t	Todos	S6X 150D		S5X 150D	
Cargo 26t/28t/29t	Todos	S6X 150D		S5X 150D	
Cargo 31t/32t/35t	Todos	S6X 150D		S5X 150D	
Cargo 40t/43t/44t/45t/50t/63t	Todos			S5X 100E	
Cargo 712/ 814/ 815	Todos			S5X 100E	
Cargo 1113/ 1114/ 1117/ 1215/ 1217/ 1218/ 1313/ 1314/ 1317	Todos	S6X 150D		S5X 150D	
Cargo 1415/ 1417/ 1418/ 1419/ 1421/ 1514/ 1517/ 1521	Todos	S6X 150D		S5X 150D	
Cargo 2319/ 2322/ 2324/ 2421/2422/ 2425/ 2428	Todos	S6X 150D		S5X 150D	
Cargo 2622/ 2626/ 2628/ 2630/ 2631/ 2632/ 2831/ 2932	Todos	S6X 150D		S5X 150D	
Cargo C-3132	Todos			S5X 100E	
Cargo 4030/ 4031/ 4331/ 4532e	Todos			S5X 100E	
Cargo 3222/ 3224/ 3530	Todos	S6X 150D		S5X 150D	
Cargo C 1317e/ 1517e/ 1717e/ 1932 R	Todos			S5X 100E	
Cargo C 2422e/ 2428e/ 2622e/ 2628e	Todos			S5X 100E	
F 350 Euro III	Todos	S6X 70E		S5X 65E	
F 600 / F 700	05.71 → 10.85	S6X 170D	S6X 150D	S5X 170D	S5X 150D
F 2000	10.80 → 12.83	S6X 170D	S6X 150D	S5X 170D	S5X 150D
F 4000	07.79 → 10.97	S6X 170D	S6X 150D	S5X 170D	S5X 150D
F 4000	12.93 → 08.05			S5X 100E	
F 4000	09.05 →	S6X 70E		S5X 65E	
F 6000	1980 →	S6X 150D		S5X 150D	
F 7000	01.78 → 10.82	S6X 150D		S5X 150D	
F 11000	01.78 → 03.92	S6X 150D		S5X 150D	
F 12000	01.78 → 12.05	S6X 150D		S5X 150D	
F 13000	10.82 → 12.87	S6X 150D		S5X 150D	
F 14000	04.92 → 12.05	S6X 150D		S5X 150D	
F 16000	12.98 → 12.05	S6X 150D		S5X 150D	
Ford Cargo	1985 → 1990			S5X 100E	
Transit	Todos	S6X 70D		S5X 65D	

IVECO

170E 22 Attack	Todos	S6X 170D			
170E 28 (S, ST, T)	Todos	S6X 170D			
240 E22 Attack	Todos	S6X 170D			
240 E28 (S, SStradale)	Todos	S6X 170D			
Cavallino	Todos			S5X 100E	
City Class 70 C16	2003 → 2007			S5X 170D	
Cursor 450E 33T	2009 →			S5X 100E	
Euro Cargo	01.05 →			S5X 100E	
Euro Tech	01.98 →	S6X 150D		S5X 150D	
Euro Trakker	01.98 →	S6X 150D		S5X 150D	
Scudato	11.99 →	S6X 95D		S5X 95D ³	
Trakker 380 T38 / 380 T42 / 720 T42	2008 →	S6X 170D		S5X 170D	
Vertis 90V16 / 130V18	2011 →			S5X 100E	
Stralis	Todos	S6X 150D		S5X 150D	





(3) S5X 95D substituída pela S6X 95D

				
Aplicação	Data de aplicação	Código simplificado Bosch		

MARCOPOLO				
Volare	01.02 →			S5X 100E
Volare A8	10.98 → 12.04	S6X 150D		S5X 150D
Volare W8/W9	01.08 →	S6X 70E		S5X 65E

MERCEDES-BENZ				
709	03.88 →			S5X 100E
710 (Eletrônico)	09.95 →			S5X 100E
712 E/C	01.03 →			S5X 100E
912	03.88 → 03.03	S6X 150D		S5X 150D
914 C/LO(Mecânico)	10.98 → 01.06	S6X 170D S6X 150D	S5X 170D	S5X 150D
915	Todos	S6X 170D S6X 150D	S5X 170D	S5X 150D
1214C	06.97 → 12.05			S5X 100E
1215C	05.99 → 12.05			S5X 100E
1318	01.03 →			S5X 100E
1621	01.98 →	S6X 150D		S5X 150D
1633	01.87 →			S5X 100E
1714 K	02.91 → 02.01	S6X 150D		S5X 150D
1718	07.90 →			S5X 100E
1720	02.98 → 12.05			S5X 100E
1721 S	12.94 → 12.04	S6X 150D		S5X 150D
1723	02.98 → 12.05			S5X 100E
1728	04.03 → 01.06			S5X 100E
1935	01.87 →			S5X 100E
1941	01.87 →			S5X 100E
1944 S	11.01 → 12.05			S5X 150D
2325	01.87 →			S5X 100E
2418	03.91 → 03.01			S5X 100E
2423	05.99 → 01.06			S5X 100E
2428	03.01 → 01.06			S5X 100E
2638	10.98 → 10.05	S6X 150D		S5X 150D
2726	01.08 →			S5X 100E
Accelo 715C/ 915C	03.03 →			S5X 100E
Atego 1315/ 1518	09.04 →	S6X 150D		S5X 150D
Atego 1418	09.04 →			S5X 100E
Atego 2425	09.04 →			S5X 100E
Atego 2428	06.07 →			S5X 100E
Axor 1933	01.05 →	S6X 150D		S5X 150D
Axor 2035	06.05 →	S6X 150D		S5X 150D
Axor 2040	06.05 →	S6X 150D		S5X 150D
Axor 2044	06.05 →	S6X 150D		S5X 150D
Axor 2533	01.05 →	S6X 150D		S5X 150D
Axor 2535	05.11 →	S6X 150D		S5X 150D
Axor 2540	06.05 →	S6X 150D		S5X 150D
Axor 2544	06.05 →	S6X 150D		S5X 150D
Axor 2640	06.05 →	S6X 150D		S5X 150D
Axor 2644	06.05 →	S6X 150D		S5X 150D
Axor 2826	06.06 →	S6X 150D		S5X 150D
Axor 2831	10.05 →	S6X 150D		S5X 150D
Axor 3340	06.05 →	S6X 150D		S5X 150D
Axor 3344	06.05 →	S6X 150D		S5X 150D
Axor 4140	01.06 →	S6X 150D		S5X 150D



				
Aplicação	Data de aplicação	Código simplificado Bosch		
MERCEDES-BENZ				
Axor 4144	01.06 →	S6X 150D	S5X 150D	
L 608 D	09.73 → 01.87	S6X 150D	S5X 150D	
L 1113	01.74 → 06.87	S6X 150D	S5X 150D	
L 1114	06.87 → 06.97		S5X 100E	
L 1115	01.85 → 12.87	S6X 150D	S5X 150D	
L 1118	06.87 → 06.97	S6X 150D	S5X 150D	
L 1214	04.89 → 04.99		S5X 100E	
L 1218	04.89 → 04.99		S5X 100E	
L 1313	08.79 → 05.85	S6X 150D	S5X 150D	
L 1314	07.87 → 07.97	S6X 150D	S5X 150D	
L 1316	01.74 → 01.99		S5X 100E	
L 1317	12.85 → 12.95		S5X 100E	
L 1318	06.87 →		S5X 100E	
L 1319	01.76 → 04.87		S5X 100E	
L 1414	04.89 → 04.99		S5X 100E	
L 1418	04.89 → 12.05		S5X 100E	
L 1513	01.74 → 06.87	S6X 150D	S5X 150D	
L 1514	07.87 → 07.97	S6X 150D	S5X 150D	
L 1516	01.74 →	S6X 150D	S5X 150D	
L 1517	12.85 → 05.89	S6X 150D	S5X 150D	
L 1518	06.87 → 12.97	S6X 150D	S5X 150D	
L 1519	05.84 → 04.87	S6X 150D	S5X 150D	
L 1520	05.87 → 05.97	S6X 150D	S5X 150D	
L 1524	10.84 → 05.87	S6X 150D	S5X 150D	
L 1525	06.87 → 06.97	S6X 150D	S5X 150D	
L 1614	04.89 → 04.99		S5X 100E	
L 1618	04.89 → 04.99		S5X 100E	
L 1620	06.96 →		S5X 100E	
L 1621	08.89 → 08.99	S6X 150D	S5X 150D	
L 1622	07.01 → 12.05		S5X 100E	
L 1625	05.90 → 05.00		S5X 100E	
L 2013	01.74 → 06.87	S6X 150D	S5X 150D	
L 2014	07.87 → 07.97	S6X 150D	S5X 150D	
L 2213	01.74 → 06.87	S6X 150D	S5X 150D	
L 2215	01.85 → 12.86	S6X 150D	S5X 150D	
L 2214	07.87 → 07.97	S6X 150D	S5X 150D	
L 2216	01.74 → 12.88	S6X 150D	S5X 150D	
L 2217	11.85 → 11.95	S6X 150D	S5X 150D	
L 2220	05.87 → 05.97	S6X 150D	S5X 150D	
L 2225	01.89 → 12.91	S6X 170D		
L 2314	09.89 → 09.99		S5X 100E	
L 2318	07.89 → 07.99		S5X 100E	
L 2325	05.90 → 05.00		S5X 100E	
L 2635	09.92 → 09.02	S6X 170D		
LA 1513	01.74 → 04.87	S6X 150D	S5X 150D	
LA 2013	01.74 → 04.87	S6X 150D	S5X 150D	
LA 2213	01.74 → 04.87	S6X 150D	S5X 150D	
LAK 1118	01.87 →	S6X 170D S6X 150D	S5X 170D S5X 150D	
LAK 1314	01.87 →	S6X 170D S6X 150D	S5X 170D S5X 150D	
LAK 1316	01.70 → 12.86	S6X 170D	S5X 170D	

				
Aplicação	Data de aplicação	Código simplificado Bosch		

MERCEDES-BENZ					
LAK 1514	01.87 →	S6X 170D	S6X 150D	S5X 170D	S5X 150D
LAK 2014	01.87 →	S6X 170D	S6X 150D	S5X 170D	S5X 150D
LAK 2214	01.87 →	S6X 170D	S6X 150D	S5X 170D	S5X 150D
LB 1513/2013/2213/1516/2215/2216	01.64 → 12.86	S6X 170D	S6X 150D	S5X 170D	S5X 150D
LB 2218	01.87 →		S6X 150D		S5X 150D
LB 2318	05.90 → 05.00				S5X 100E
LB 2325	01.90 →		S6X 150D		S5X 150D
LK 2215	01.84 → 12.86		S6X 150D		S5X 150D
LO 608 D	09.73 → 01.87	S6X 170D	S6X 150D	S5X 170D	S5X 150D
LO 708 E	02.87 → 12.90		S6X 170D		S5X 170D
LO 809	03.88 → 03.98				S5X 100E
LO 812	03.88 → 03.98	S6X 170D	S6X 150D	S5X 170D	S5X 150D
LO 814	06.97 → 12.05		S6X 150D		S5X 150D
LO 915	01.04 →				S5X 100E
LPO 1113	06.74 → 06.94		S6X 150D		S5X 150D
LPO 1520	01.64 → 12.86		S6X 170D		S5X 170D
LS 1524	10.84 → 05.87		S6X 150D		S5X 150D
LS 1525	06.87 → 06.97		S6X 150D		S5X 150D
LS 1625/LS 1630	05.90 → 05.00				S5X 100E
LS 1634	10.03 →		S6X 150D		S5X 150D
LS 1933	02.87 → 04.88		S6X 150D		S5X 150D
LS 1934	04.88 → 04.98		S6X 150D		S5X 150D
LS 1935	05.90 → 05.00		S6X 150D		S5X 150D
LS 1938	10.98 → 12.05		S6X 150D		S5X 150D
LS 1941	05.90 → 05.00				S5X 100E
O321	01.58 → 12.86				S5X 200D
O355	01.74 →	S6X 170D	S6X 150D	S5X 170D	S5X 150D
O362	01.75 →				S5X 200D
O364	06.76 → 01.90		S6X 150D		S5X 150D
O365	10.87 → 10.97		S6X 150D		S5X 150D
O370	08.84 → 08.99		S6X 150D		S5X 150D
O371	03.86 → 07.03		S6X 150D		S5X 150D
OF 113	01.70 → 12.86	S6X 170D	S6X 150D	S5X 170D	S5X 150D
OF 812	05.91 → 05.01		S6X 150D		S5X 150D
OF 1113	01.88 →		S6X 150D		S5X 150D
OF 1114	01.87 → 01.97				S5X 100E
OF 1115	09.87 → 09.97		S6X 150D		S5X 150D
OF 1218	05.08 →				S5X 100E
OF 1314	01.87 → 01.97		S6X 150D		S5X 150D
OF 1315	09.87 → 09.97		S6X 150D		S5X 150D
OF 1318	01.88 → 01.98		S6X 150D		S5X 150D
OF 1418	01.04 →				S5X 100E
OF 1618	01.92 → 12.96				S5X 100E
OF 1620	10.93 → 10.03		S6X 150D		S5X 150D
OF 1721	03.98 → 12.05		S6X 150D		S5X 150D
OF 1722	01.04 →		S6X 150D		S5X 150D
OH 113	01.70 → 12.86		S6X 170D	S5X 200D	S5X 170D
OH 355	06.74 → 06.94				S5X 200D
OH 1113	01.88 →		S6X 170D		S5X 170D
OH 1313	01.82 →		S6X 150D	S5X 200D	S5X 150D
OH 1314	01.87 → 01.97		S6X 150D	S5X 200D	S5X 150D



				
Aplicação	Data de aplicação	Código simplificado Bosch		

MERCEDES-BENZ

OH 1315	09.87 → 09.97		S5X 200D	
OH 1316	10.83 → 10.98	S6X 150D	S5X 150D	
OH 1317	01.88 → 12.89		S5X 100E	
OH 1318	01.88 → 01.98		S5X 200D	
OH 1419	06.76 → 06.96	S6X 150D	S5X 150D	
OH 1420	10.87 → 12.05	S6X 150D	S5X 150D	
OH 1517	05.77 → 05.97	S6X 150D	S5X 150D	
OH 1518	06.87 → 06.97	S6X 150D	S5X 150D	
OH 1519		S6X 150D	S5X 150D	
OHL 1621	01.98 →	S6X 150D	S5X 150D	
OHL 1625	01.96 → 12.96		S5X 100E	

SCANIA

F 112 / 203HL / 305HL	05.84 → 12.91	S6X 150D	S5X 150D	S4X 115D
F 113HL / HR	01.90 → 12.98	S6X 170D	S5X 170D	
F 113 / 220	10.90 → 12.98	S6X 170D	S5X 170D	
F 113 / 310	10.90 → 12.98	S6X 170D	S5X 170D	
G 380	10.07 →	S6X 150D	S5X 150D	
G 420	10.07 →		S5X 180E	
G 440 / G 470	10.07 →	S6X 170D	S5X 170D	
K 112 / 203 / 305 / 333	07.83 → 12.91	S6X 150D	S5X 150D	S4X 115D
K113CL / 203 / 250 / 303 / 310 / 320 / 343 / 354 / 360 / 362 / 380	01.90 → 12.99	S6X 150D	S5X 150D	S4X 115D
K 310 Urbano	01.05 →		S5X 180E	
K 250		S6X 150D	S5X 150D	
K 310		S6X 150D	S5X 150D	
K 360		S6X 150D	S5X 150D	
K 420 Rodoviário	01.05 →		S5X 180E	
L 94 / 220 / 260 / 310	05.98 → 12.05		S5X 180E	
L 113 / 203	10.90 → 12.94		S5X 180E	
L 113 / 220	10.90 → 12.94	S6X 150D	S5X 150D	
Ônibus Urbano	01.79 →	S6X 150D	S5X 150D	
P 94 / 260	03.98 → 12.05	S6X 170D		
P 93 / 250	04.95 → 12.98	S6X 150D	S5X 150D	
P 114 / 322	09.99 → 12.05	S6X 170D		
P 124 / 360 / 420	03.98 → 12.05	S6X 170D		
P 124 / 400	03.01 → 12.05	S6X 170D		
P 270	01.05 →	S6X 170D		
P 420	01.05 →		S5X 180E	
P 310	01.05 →		S5X 180E	
R 112 / 203	06.85 → 06.89	S6X 150D	S5X 150D	
R 112 / 310	07.89 → 08.91	S6X 150D	S5X 150D	
R 112 / 316	01.81 → 06.89	S6X 150D	S5X 150D	
R 112 / 360	07.89 → 08.91		S5X 180E	
R 113 / 203 / 310 / 320 / 362 / 363	10.91 → 12.98	S6X 150D	S5X 150D	S4X 115D
R 124 / 360 / 400 / 420	03.98 → 12.05		S5X 180E	
R 143 / 450	10.96 → 06.98	S6X 150D	S5X 150D	
R 380	01.05 →	S6X 150D	S5X 150D	
R 400 / 420 / 480 / 560	10.07 →		S5X 180E	
R 440	10.07 →		S5X 180E	
R 470	10.07 →	S6X 150D		

				
Aplicação	Data de aplicação	Código simplificado Bosch		

SCANIA

R 500	10.07 →			S5X 180E	
S113 / 203CL / 204CL / 303AL / CL / 310AL / CL	11.90 → 12.94	S6X 150D		S5X 150D	S4X 115D
Série 4 Caminhões	Todos			S5X 180E	
Série 4 Ônibus	01.99 →			S5X 180E	
T112 / 203 / 310 / 316 / 360	01.81 → 08.91	S6X 150D		S5X 150D	S4X 115D
T113 / 203 / 310 / 320 / 362 / 363	09.91 → 06.98	S6X 150D		S5X 150D	S4X 115D
T124 / 360 / 400 / 420	03.98 → 12.05			S5X 180E	
T143 / 450	09.91 → 06.96	S6X 170D			

VOLKSWAGEN

5-140 / 6-80 / 6-90 / 7-90 / S7-110 / 8-120 / 8-150 / 9-140	01.83 → 10.86			S5X 100E	
7.90 / 7.100 / 7.110	10.87 → 12.05			S5X 100E	
8.120 / 8.140 / 8.150 / 9.140	03.94 →			S5X 100E	
9-150 / 9-150 Plus	11.00 →	S6X 150D		S5X 150D	
11.140 / 11.160 / 12.660	Todos			S5X 100E	
12.140 H / 12.140 T / 12.170 BT / 12.180	03.94 → 02.00	S6X 170D		S5X 170D	
13.130 / 13.180 / 13.190	03.81 →	S6X 150D		S5X 150D	
13.150	01.00 → 12.05			S5X 100E	
14.150 / 14.200 / 14.220	07.91 → 02.00	S6X 170D		S5X 170D	
15.180 / 15.190	01.00 →	S6X 170D S6X 150D	S5X 170D	S5X 150D	S4X 115D
16.170 / 16.180 / 16.210	02.88 → 08.01	S6X 150D		S5X 150D	
17.210 / 17.220 / 17.240	11.00 →	S6X 170D S6X 150D	S5X 170D	S5X 150D	S4X 115D
18.310 / 18.350	05.01 → 12.05	S6X 150D		S5X 150D	
22.140 / 22.160	10.86 → 12.89	S6X 170D S6X 150D	S5X 170D	S5X 150D	S4X 115D
23.210 / 23.220	05.01 → 12.05	S6X 170D S6X 150D	S5X 170D	S5X 150D	S4X 115D
24.220	2011 →			S5X 170D	
24.250	05.92 → 01.02	S6X 170D		S5X 170D	
26.220 / 26.260	11.01 →	S6X 170D S6X 150D	S5X 170D	S5X 150D	S4X 115D
31.260	02.05 →	S6X 170D S6X 150D	S5X 170D	S5X 150D	S4X 115D
31.310	01.05 →			S5X100E	
E11 / E13 / E21	01.80 →			S5X100E	
CONSTELLATION 31.320 / 31.370	2011 →			S5X 100E	
CONSTELLATION 24.320	2011 →	S6X 150D			
CONSTELLATION 13.180 / 15.180 / 17.250	2011 →			S5X 100E	
CONSTELLATION CABINE ESTENDIDA 24.250 / 25.370 / 25.320 / 26.260 / 31.260	2011 →			S5X 100E	
CONSTELLATION CABINE LEITO 24.250 / 25.370 / 25.320 / 26.260 / 31.260	2011 →	S6X 150D			
CONSTELLATION CABINE ESTENDIDA 19.320 TRACTOR / 19.370 TRACTOR	2011 →			S5X 100E	
CONSTELLATION CABINE LEITO 19.320 TRACTOR / 19.370 TRACTOR	2011 →	S6X 150D			
CONSTELLATION 25.370 TRACTOR	2011 →	S6X 150D			
DELIVERY 9.150 / 5-140	2011 →			S5X 100E	
E11 / E13 / E21	Todos			S5X 100E	
Titan 18.310	Todos			S5X 100E	
Titan Constellation 13.180 / 24.250 / 23.250	Todos			S5X 100E	
Titan Constellation 15.180 / 15.190 / 19.320	Todos	S6X 150D		S5X 150D	
Worker 9.150 E Electronic	07.03 → 03.12	S6X 150D		S5X 150D	
Worker 13.170 E Electronic	02.04 → 12.06	S6X 170D			
Worker 13.180	01.06 → 03.12			S5X 100E	
Worker 13.180 E Electronic	06.05 → 03.12	S6X 150D		S5X 150D	



				
Aplicação	Data de aplicação	Código simplificado Bosch		

VOLKSWAGEN

Worker 13.190	Todos	S6X 150D	S5X 150D	
Worker 15.180 E Electronic	06.05 → 03.12	S6X 150D	S5X 150D	
Worker 15.180	01.06 → 03.12	S6X 150D	S5X 150D	
Worker 15.190	Todos	S6X 150D	S5X 150D	
Worker 15.190 E Electronic	12.04 → 03.12	S6X 150D	S5X 150D	
Worker 17.220	04.06 → 03.12	S6X 150D	S5X 150D	
Worker 23.250 E Electronic	02.04 → 12.06		S5X 100E	
Worker 24.250 E Electronic	07.03 → 03.12		S5X 100E	
Worker 26.220	04.06 → 03.12	S6X 150D	S5X 150D	
Worker 26.260 E Electronic	01.06 → 03.12	S6X 150D	S5X 150D	
Worker 26.260	Todos	S6X 150D	S5X 150D	
Worker 31.260 E Electronic	01.06 → 03.12	S6X 150D	S5X 150D	
VM 310	Todos		S5X 100E	
Worker 31.260	Todos	S6X 150D	S5X 150D	

VOLVO

B10M	01.87 → 07.01	S6X 150D	S5X 150D	S4X 115D
B10M Articulado	06.90 → 12.03		S5X 200D	
B10R	01.00 → 12.03		S5X 200D	
B12M/R	03.94 →	S6X 150D	S5X 150D	S4X 115D
B58E	01.85 → 12.98	S6X 150D	S5X 150D	S4X 115D
B58E Articulado	09.83 → 12.98		S5X 200D	
B7R	06.97 → 12.05		S5X 200D	
FH 12380 / 420 / 460	08.93 → 09.03	S6X 170D		
FH 12380 / 420 / 460	09.03 →		S5X 180E	
FM 370 / 400 / 440 / 480	09.06 →	S6X 170D		
FM 10320	03.00 → 09.03	S6X 150D	S5X 150D	S4X 115D
FM 12340 / 380 / 420	03.00 → 09.03	S6X 150D	S5X 150D	S4X 115D
N 104 / 10XH / 10XHT	01.79 →	S6X 150D	S5X 150D	
N 1016 / N1020 / N1033	01.79 →	S6X 150D	S5X 150D	
N 10258 / 270 / 275 / 290 / 300 / 330	07.80 → 12.88	S6X 150D	S5X 150D	S4X 115D
N 12330 / 385	01.81 → 12.88	S6X 150D	S5X 150D	S4X 115D
NH12380 / 420 / 460	05.98 → 09.03	S6X 170D		
NH12420 / 460	10.03 →		S5X 180E	
NL10280 / 300 / 310 / 320 / 340	06.89 → 12.99	S6X 150D	S5X 150D	S4X 115D
NL12310 / 320 / 340 / 360 / 380 / 400 / 410	10.89 → 12.99	S6X 150D	S5X 150D	S4X 115D
Ônibus	01.99 →		S5X 180D	
VM 17	03.03 → 12.05	S6X 170D		
VM 23	03.03 → 12.05	S6X 170D		
VM 210	01.06 →	S6X 170D		
VM 260	01.06 →	S6X 170D		
VM 310	01.06 →	S6X 170D		

				
Aplicação	Data de aplicação	Código simplificado Bosch		

AGRALE-DEUTZ				
415 / 416 / 420 / 440	01.69 → 12.79		S5X 55D	
5070 / 5075 / 5080 / 5085	09.94 →	S6X 150D	S5X 150D	S4X 115D
6150	08.99 → 12.08	S6X 150D	S5X 150D	S4X 115D
AG 4100 / 4118 / 4120 / 4200 / 4230 / 4240 / 4300	12.74 →		S5X 45D	
BX 60 / 90 / 100 / 130	08.90 → 08.05	S6X 150D	S5X 150D	S4X 115D
BX4.60 / 4.90	08.90 → 08.05	S6X 150D	S5X 150D	S4X 115D
BX4.100 / 4.110 / 4.130 / 4.150	08.90 → 08.05	S6X 150D	S5X 150D	S4X 115D
BX6.110 / 6.1506.180	12.95 → 12.05	S6X 150D	S5X 150D	S4X 115D
M 790/M 80/M 85/M 90	01.70 →	S6X 60D	S5X 55D	

CASE				
Colheitadeira Axial Flow 284cv	Todos		S5X 100E	
Escavadeira CX 220	01.02 →		S5X 100E	
Motoniveladora 845	01.02 →		S5X 100E	
Pá Carregadeira Compacta 40XT / 60XT / 70XT / 75XT	Todos	S6X 70D	S5X 65D	
Pá Carregadeira 521D / 621D / 721D / 821C / 921C	01.02 →		S5X 100E	
Pá Carregadeira W20 / 30 / 36	03.74 → 05.06	S6X 150D	S5X 150D	S4X 115D
Retroescavadeira 580 H/580L	01.84 → 04.04		S5X 100E	
Trator mxm maxxum 137-177 CV	Todos	S6X 70D	S5X 65D	
Trator MX 220 / 240 / 270	06.03 →	S6X 70D	S5X 65D	
Trator MXM 135 / 150 / 165 / 180	10.03 →	S6X 70D	S5X 65D	

CATERPILLAR				
Caminhões Fora de Estrada 769 / 777 / 773E / 775E	Todos		S5X 200D	
Caminhões Fora de Estrada R-22 / 33303	01.73 →		S5X 200D	
Caminhões Fora de Estrada R-35 / R-70	01.76 →		S5X 200D	
Caminhões T / TT-24T D'água	01.79 →		S5X 200D	
Carregadeiras de Rodas 920 / 955 / 973 / 977 / 980 / 988	Todos		S5X 200D	
Motoniveladora 14 / 16 / 112	Todos		S5X 200D	
Moto Scrapers F-24 / TS-24	Todos		S5X 200D	
Moto Scrapers TS-14R	01.73 →	S6X 150D	S5X 150D	
Trator D3 / D4 / D5 / D6C / 966C	Todos	S6X 150D	S5X 150D	
Trator D7 / D8 / DL8 / D9N	Todos		S5X 200D	

CLARK				
C 300-HY40 / 50 / 60 / C500-HY70 / 80	Todos		S5X 100E	
C 500 / Y100 / Y135 / 155	01.81 →		S5X 200D	
Carregadeira 45C / 55-A2E2.1 / 2JC	Todos	S6X 150D	S5X 150D	
Carregadeira 125ART / 125X / 75-III / 75HD	01.70 →	S6X 150D	S5X 150D	
Guindaste AM 720	01.78 →		S5X 200D	

ENGESA				
EE 815 / 510	01.75 →	S6X 150D	S5X 150D	
EE 1124 / 1128 / 1428	01.80 →		S5X 200D	

FIAT-ALLIS				
7BTA / 14B / 14CSTA / 14CS	Todos	S6X 150D	S5X 150D	S4X 115D
AD7B / AD14C / AD148 / AD20	06.85 → 04.01	S6X 150D	S5X 150D	S4X 115D
FL4C / FL8C / S9	01.70 → 12.82	S6X 150D	S5X 150D	S4X 115D



				
Aplicação	Data de aplicação	Código simplificado Bosch		

FORD NEW HOLLAND

5030	05.92 → 05.07		S5X 100E	
7630	06.94 → 07.07		S5X 100E	
8430DT	12.93 → 12.03	S6X 150D	S5X 150D	S4X 115D
8630DT / 8830DT	12.93 → 12.03	S6X 170D	S5X 170D	
TC57 / 59	08.96 → 08.06	S6X 170D		
TL65 / 70 / 80 / 90 / 100	09.97 → 09.07		S5X100E	

HUBER WARCO / DRESSER

150A	01.73 →		S5X 200D	
------	---------	--	----------	--

JOHN DEERE

Colheitadeira 1165 / 1175 / 1450 / 1550 / 1650	01.98 → 12.05	S6X 150D	S5X 150D	
Colheitadeira 9650 / 9660 / 9750	01.02 →	S6X 150D	S5X 150D	
Colheitadeira (Cana) CH2500B	Todos		S5X 100E	
FORAGEIRAS	Todos	S6X 150D	S5X 150D	
Pulverizador 4720	01.02 →		S5X 100E	
Trator 5403 / 5605 / 5705 / 6415	01.02 →		S5X 100E	
Trator 6615 / 7515 / 7815 / 8420	01.02 →	S6X 150D	S5X 150D	

KOMATSU

Trator D30E / D50A	05.75 → 11.93	S6X 150D	S5X 150D	S4X 115D
Trator D60E / D60F	06.90 → 06.05		S5X 200D	

MALVES

MD 850 / 920P / 2100	Todos	S6X 150D	S5X 150D	S4X 115D
----------------------	-------	----------	----------	----------

MASSEY-FERGUSON

Colheitadeira 210 / 220 / 1630	Todos		S5X 100E	
Colheitadeira MF 34 / MF 35	01.01 → 12.06	S6X 150D	S5X 150D	
Colheitadeira MF 3640 / 3650	01.73 →	S6X 150D	S5X 150D	
Retroescavadeira 750	Todos	S6X 150D	S5X 150D	
Retroescavadeira 751	Todos		S5X 75D	
Retroescavadeira MF 86HS / MF 96	Todos		S5X 100E	
Trator MF 250 / 265 / 266 / 272 / 275 / 283 / 285 / 290 / 292	01.71 →		S5X 100E	
Trator MF 295 / 296 / 297 / 299	01.78 →	S6X 150D	S5X 150D	S4X 115D
Trator 4780	01.83 →	S6X 150D	S5X 150D	S4X 115D
Trator 50 / 55X / 65 / 65X / 85 / 85R / 85X / 86 / 95X	Todos		S5X 100E	
Trator MF 3000 / 5275 / 5285 / 5290	02.98 → 02.09		S5X 100E	
Trator MF610 / 620	Todos		S5X 100E	
Trator MF630 / 640 / 650 / 660 / 680 / 970	Todos	S6X 150D	S5X 150D	
Trator MF6350 / 6360	10.04 →	S6X 170D	S5X 170D	
Trator MF6855 / 9090	Todos		S5X 100E	
Trator 9150 / 9170 (Turbo)	01.89 →		S5X 100E	

MÜLLER

AP 20 / 23 / 26 / 35	01.69 →	S6X 150D	S5X 150D	
Escavadeira	01.74 →	S6X 150D	S5X 150D	
Trator TC-15B	01.73 →	S6X 150D	S5X 150D	
Trator TC-20	01.73 →		S5X 100E	

				
Aplicação	Data de aplicação	Código simplificado Bosch		

MÜLLER				
TI-18 / 25 / TC18 / 23 / 28	01.73 →	S6X 150D	S5X 150D	
TM 12 / TM 14	04.89 → 04.04	S6X 150D	S5X 150D	S4X 115D
TM 12 / 14 / 17 / 25 / 31	01.73 →		S5X 150D	
VAP-70	01.74 →	S6X 150D	S5X 150D	

NEW HOLLAND				
4830 / 5030 / 6630 / 7630 / 7830	05.92 → 05.07		S5X 100E	
8030 / 8430	04.94 → 07.07	S6X 150D	S5X 150D	S4X 115D
8630 / 8830	04.94 → 04.04	S6X 170D	S5X 170D	
Motoniveladora RG140.B / RG170B / RG200.B	Todos		S5X 100E	
Pá Carregadeira 12B / W130TC / W160 / W200	Todos		S5X 100E	
Retroescavadeira LB90 / LB110	Todos		S5X 100E	
TL com cabine	Todos		S5X 100E	
TL sem cabine / 7630	Todos		S5X 100E	
Trator Colheitadeira TL 62 a 98 CV	Todos		S5X 100E	
Trator Colheitadeira TC / Plataforma de Grãos	Todos	S6X 170D	S5X 170D	
Trator Colheitadeira TM 110 / 120 / 130 / 140 / 180	Todos	S6X 70D	S5X 65D	
Trator Colheitadeira TS 100 / 110 / 120	Todos	S6X 150D	S5X 150D	
Trator Colheitadeira SÉRIE 30 S100 104,4 a 120,9CV	Todos		S5X 100E	
Trator Colheitadeira TL 62 a 98 CV	Todos		S5X 100E	
Trator Colheitadeira CS660	01.04 →	S6X 95D	S5X 95D ³	
Trator de Esteira 7D / D130 / D170	Todos		S5X 100E	

POCLAIN				
2T / 4 / T / 67	01.78 →	S6X 150D	S5X 150D	

RANDON				
RK628C / 425B / 430B / 435N	Todos	S6X 150D	S5X 150D	

SCANIA				
DN11.47A37S	06.91 →	S6X 150D	S5X 150D	

SLC				
7200 Turbo	06.86 → 06.01	S6X 150D	S5X 150D	

SVEDALA DYNAPAC				
COMPACT. VIBRATÓRIO MODO C A25-M	Todos	S6X 150D	S5X 150D	

TEMA TERRA				
597-C / 5299 / 5300 / 5530 / 5720	01.75 →	S6X 150D	S5X 150D	
84BPulv.-Mist.Solo	01.71 → 12.76	S6X 150D	S5X 150D	
SP-225	01.69 →		S5X 100E	
SP-5550	01.74 →		S5X 100E	
SP-8000 / SP-120000	Todos	S6X 150D	S5X 150D	
SPV-735 / 755-VA / VP-15D / VP-15DP	01.71 →		S5X 100E	
SSPRM-7	01.77 →	S6X 150D	S5X 150D	
TH-10 / TH-14 / TT-1014	Todos		S5X 100E	
TT-4420	01.76 →	S6X 150D	S5X 150D	

(3) S5X 95D substituída pela S6X 95D



				
Aplicação	Data de aplicação	Código simplificado Bosch		

TEREX

Moto Niveladora 619 SÉRIE C 922 / 933 / 944 / 955 / 966 / 977	01.60 → 01.63		S5X 100E	
Pá Carregadeira 72-51 / 72-52	01.74 →		S5X 200D	
Scrapers 621B, 62-7B / PP631D, 637-D / PP769B / C	Todos		S5X 200D	
Scrapers TS-14	01.78 →		S5X 200D	
Scrapers TS-24A / F-24A	01.78 →		S5X 200D	

VALMET

78 / 85 / 88	12.73 → 01.00		S5X 100E	
110 / 118 / 128 / 138 / 148	12.73 → 07.01		S5X 100E	
980 / 985 / 1180 / 1280 / 1580 / 1780	08.90 → 03.05		S5X 100E	
685 / 785 / 880 / 885 / 985	01.86 → 08.04		S5X 100E	
700 / 800 / 900	Todos		S5X 100E	
985	10.01 → 10.06		S5X 100E	

VALTRA DO BRASIL

1580 / 1780	10.01 → 10.06		S5X 100E	
BF65 / 75	10.01 →		S5X 100E	
BH140 / 160 / 180	10.01 →		S5X 100E	
BL88	01.03 → 01.08		S5X 100E	
BM100 / 110 / 120	10.01 →		S5X 100E	
Trator série 100	Todos		S5X 100E	

VOLVO

Caminhões Fora de Estrada A 25D / A 30D / A 35D / A 40D	Todos		S5X 180E	
---	-------	--	----------	--

WABCO

Caminhões Fora de Estrada	Todos		S5X 200D	
---------------------------	-------	--	----------	--

YALE

Empilhadeira com motor VW1300	01.80 →		S5X 45D	
-------------------------------	---------	--	---------	--

ZECTOR

Tratores	Todos		S5X 200D	
----------	-------	--	----------	--